



DOC022.53.80451

# **Pocket Colorimeter II**

User Manual

04/2014, Edition 1



# Table of Contents

---

<b>Section 1 Specifications</b> .....	3
<b>Section 2 General information</b> .....	5
2.1 Safety information .....	5
2.1.1 Use of hazard information .....	5
2.1.2 Precautionary labels .....	6
2.1.3 Certification .....	6
2.2 Product overview .....	7
<b>Section 3 Startup</b> .....	9
3.1 Install the batteries .....	9
3.2 Install the cap cord .....	10
<b>Section 4 User interface and navigation</b> .....	11
4.1 Keypad description .....	11
4.2 Display description .....	11
<b>Section 5 Operation</b> .....	13
5.1 Configure the instrument .....	13
5.2 Run a test .....	13
5.3 Show the recorded measurements .....	16
5.4 Standard calibration adjust .....	17
5.4.1 Adjust the factory calibration with a standard .....	17
5.4.2 Set the standard calibration adjust to off .....	18
5.5 User-entered calibration .....	18
5.5.1 Channel restrictions .....	18
5.5.2 Enter a calibration curve with standards .....	19
5.5.3 Enter a calibration curve with the keypad .....	20
5.5.4 Remove a calibration point .....	21
5.5.5 Set to the factory default calibration .....	22
<b>Section 6 Maintenance</b> .....	23
6.1 Clean the instrument .....	23
6.2 Clean the sample cells .....	23
6.3 Replace the batteries .....	24
<b>Section 7 Troubleshooting</b> .....	25
<b>Section 8 Replacement parts</b> .....	27



# Section 1 Specifications

---

Specifications are subject to change without notice.

Specification	Details
Dimensions (W x D x H)	6.1 x 3.2 x 15.2 cm (2.4 x 1.25 x 6 in.)
Enclosure	IP67, waterproof at 1 m (3.3 ft) for 30 minutes (battery compartment not included). Keep out of direct sunlight.
Light source	Light emitting diode (LED)
Detector	Silicon photodiode
Display	LCD with backlight
Weight	0.2 kg (0.43 lb)
Pollution degree	2
Installation category	I
Protection class	3
Power requirements	4 AAA batteries; approximate life of 2000 tests (use of backlight decreases this number) Rechargeable batteries are not recommended.
Operating environment	0 to 50 °C (32 to 122 °F), 0 to 90% relative humidity non-condensing
Storage temperature	-20 to 55 °C (-7.6 to 131 °F)
Photometric precision	± 0.0015 Abs
Wavelength	Fixed wavelength ±2 nm, different for each model
Filter bandwidth	15 nm
Absorbance range	0 to 2.5 Abs
Sample cell path length	1 cm (5–10 mL), 25 mm (10 mL)
Data storage	Last 10 measurements
Certifications	CE mark
Warranty	2 years



## Section 2 General information

---

In no event will the manufacturer be liable for direct, indirect, special, incidental or consequential damages resulting from any defect or omission in this manual. The manufacturer reserves the right to make changes in this manual and the products it describes at any time, without notice or obligation. Revised editions are found on the manufacturer's website.

### 2.1 Safety information

#### **NOTICE**

The manufacturer is not responsible for any damages due to misapplication or misuse of this product including, without limitation, direct, incidental and consequential damages, and disclaims such damages to the full extent permitted under applicable law. The user is solely responsible to identify critical application risks and install appropriate mechanisms to protect processes during a possible equipment malfunction.

Please read this entire manual before unpacking, setting up or operating this equipment. Pay attention to all danger and caution statements. Failure to do so could result in serious injury to the operator or damage to the equipment.

Make sure that the protection provided by this equipment is not impaired. Do not use or install this equipment in any manner other than that specified in this manual.

#### 2.1.1 Use of hazard information

##### **▲ DANGER**

Indicates a potentially or imminently hazardous situation which, if not avoided, will result in death or serious injury.

##### **▲ WARNING**

Indicates a potentially or imminently hazardous situation which, if not avoided, could result in death or serious injury.

##### **▲ CAUTION**



Indicates a potentially hazardous situation that may result in minor or moderate injury.

### NOTICE

Indicates a situation which, if not avoided, may cause damage to the instrument. Information that requires special emphasis.

#### 2.1.2 Precautionary labels

Read all labels and tags attached to the instrument. Personal injury or damage to the instrument could occur if not observed. A symbol on the instrument is referenced in the manual with a precautionary statement.

	This symbol, if noted on the instrument, references the instruction manual for operation and/or safety information.
	Electrical equipment marked with this symbol may not be disposed of in European domestic or public disposal systems. Return old or end-of-life equipment to the manufacturer for disposal at no charge to the user.

#### 2.1.3 Certification

##### Canadian Radio Interference-Causing Equipment Regulation, IECS-003, Class A:

Supporting test records reside with the manufacturer.

This Class A digital apparatus meets all requirements of the Canadian Interference-Causing Equipment Regulations.

Cet appareil numérique de classe A répond à toutes les exigences de la réglementation canadienne sur les équipements provoquant des interférences.

##### FCC Part 15, Class "A" Limits

Supporting test records reside with the manufacturer. The device complies with Part 15 of the FCC Rules. Operation is subject to the following conditions:

1. The equipment may not cause harmful interference.
2. The equipment must accept any interference received, including interference that may cause undesired operation.



Changes or modifications to this equipment not expressly approved by the party responsible for compliance could void the user's authority to operate the equipment. This equipment has been tested and found to comply with the limits for a Class A digital device, pursuant to Part 15 of the FCC rules. These limits are designed to provide reasonable protection against harmful interference when the equipment is operated in a commercial environment. This equipment generates, uses and can radiate radio frequency energy and, if not installed and used in accordance with the instruction manual, may cause harmful interference to radio communications. Operation of this equipment in a residential area is likely to cause harmful interference, in which case the user will be required to correct the interference at their expense. The following techniques can be used to reduce interference problems:

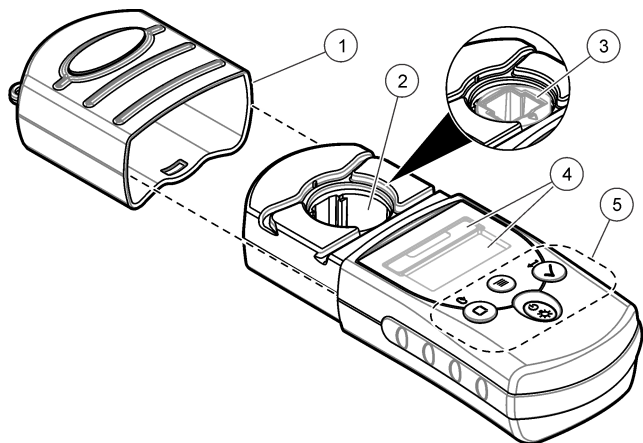
1. Move the equipment away from the device receiving the interference.
2. Reposition the receiving antenna for the device receiving the interference.
3. Try combinations of the above.

## 2.2 Product overview

This instrument is a portable filter photometer used for testing water. Refer to [Figure 1](#). This instrument is configured at the factory to measure one or two specific parameters. This instrument is calibrated at the factory. No user calibration is necessary.

**Note:** *This instrument has not been evaluated to measure chlorine and chloramines in medical applications in the United States.*

**Figure 1 Instrument overview**



1 Instrument cap	3 Cell holder with 1-cm cell adapter <sup>1</sup>	5 Keypad
2 Cell holder	4 Display	

<sup>1</sup> Factory installed in some models

## Section 3 Startup

### 3.1 Install the batteries

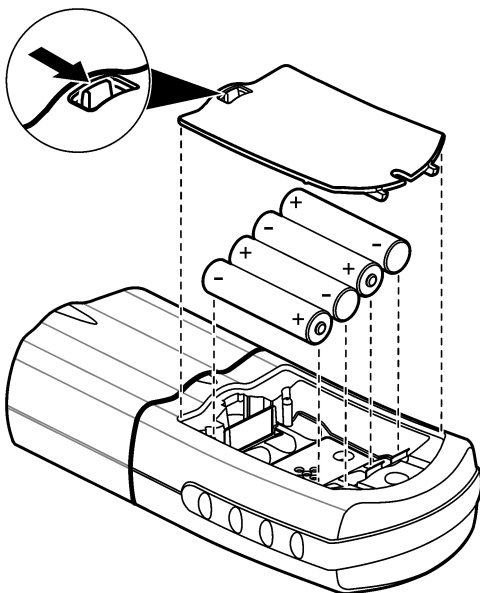
#### ⚠ WARNING



Explosion hazard. Incorrect battery installation can cause the release of explosive gases. Be sure that the batteries are of the same approved chemical type and are inserted in the correct orientation. Do not mix new and used batteries.

Install the batteries as shown in [Figure 2](#).

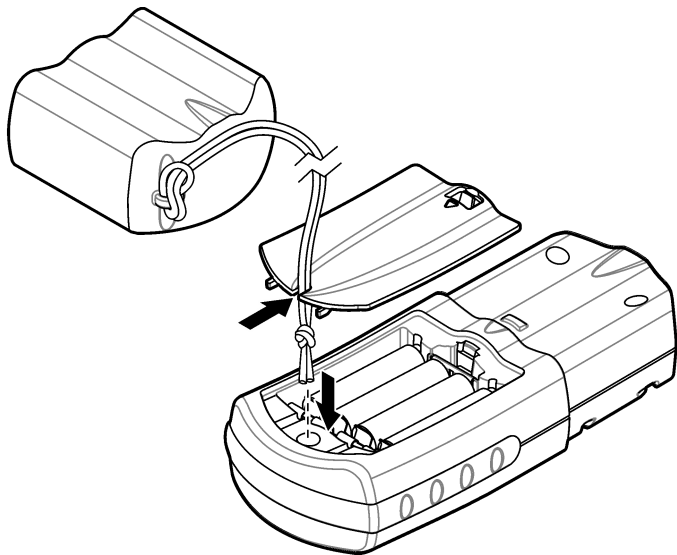
**Figure 2 Install the batteries**



### 3.2 Install the cap cord

Attach the cap cord to prevent loss of the instrument cap. Refer to [Figure 3](#).

**Figure 3** Install the cap cord

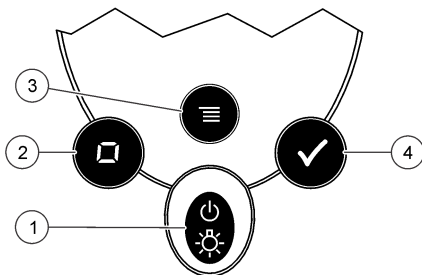


## Section 4 User interface and navigation

### 4.1 Keypad description

Figure 4 shows the keypad and gives the key functions.

Figure 4 Keypad



<b>1 Power/Backlight key:</b> Sets the power to on and off. Push and hold for 1 second to set the backlight to on or off.	<b>3 Menu key:</b> Enters and goes out of menu mode.
<b>2 Zero/Scroll key:</b> Sets the instrument to zero, scrolls through menu options and numbers	<b>4 Read/Enter key:</b> Starts a sample measurement, selects a menu option, moves the cursor to the next digit

### 4.2 Display description

Figure 5 shows the values and icons shown on the display.




Figure 5 Display




<b>1 Numeric display:</b> Measured value or menu options	<b>4 Menu icon:</b> The instrument is in menu mode.
<b>2 Range icon:</b> Selected range or parameter	<b>5 Calibration adjusted icon:</b> The factory default calibration was adjusted or a user-entered calibration curve was entered. Refer to the expanded user manual on the manufacturer's website.
<b>3 Range value:</b> Range(s) or parameters	<b>6 Low battery icon:</b> Battery level is 10%. Flashes when the battery level is too low to complete measurements.

## Section 5 Operation

### 5.1 Configure the instrument

1. Push .
2. Push  to scroll through the menu options. Push  to select an option.

Option	Description
<b>SEL</b>	Sets the measurement range or parameter. Push  to toggle between the measurement ranges or parameters.
<b>00:00</b>	Sets the time in 24-hour format (hh:mm). Push  to change the time. Push  to change the first digit, then  to go to the next digit.
<b>rCL</b>	Shows the last 10 measurements recorded. Push  to show the recorded measurements (01—most recent measurement, 10—oldest measurement). Push  to scroll through the measurements. To select a measurement by number, push  to select the number and then  . Push  to go out of this option.
<b>SCA</b>	Refer to <a href="#">Standard calibration adjust</a> on page 17.

3. Push  to go back to measurement mode.

### 5.2 Run a test

#### WARNING



Chemical exposure hazard. Obey laboratory safety procedures and wear all of the personal protective equipment appropriate to the chemicals that are handled. Refer to the current safety data sheets (MSDS/SDS) for safety protocols.

The basic measurement steps necessary to run a test follow. Refer to the applicable method to run a specific test.

1. Select the applicable measurement range or parameter. Refer to [Configure the instrument](#) on page 13.
2. Prepare the blank according to the method document. Make sure to use the correct sample cell size. Rinse the sample cell and cap with the blank before the sample cell is filled.

## Operation

---



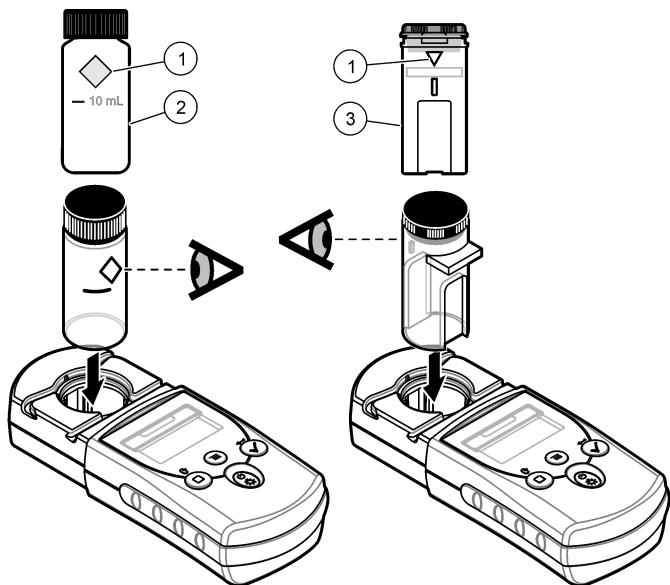
3. Close the sample cell and clean the optical faces of the sample cell with a lint-free cloth.
4. Insert the blank sample cell into the cell holder. Make sure to install the blank sample cell in the correct and consistent orientation so that the results are more repeatable and precise. Refer to [Figure 6](#).
5. Install the instrument cap over the cell holder. Refer to [Figure 7](#).
6. Push  to set the instrument zero. The display shows "0.000", or the degree of resolution that was previously selected.
7. Prepare the sample. Rinse the sample cell and cap with the sample three times before the sample cell is filled. Add reagents as specified by the method document.
8. Close the sample cell and clean the optical surfaces of the cell with a lint-free cloth.
9. Insert the sample into the cell holder. Make sure to install the sample cell in the correct and consistent orientation so that the results are more repeatable and precise. Refer to [Figure 6](#).
10. Install the instrument cap over the cell holder. Refer to [Figure 7](#).
11. Push . The display shows the results in concentration units or absorbance.  
*Note: The result flashes if the result is less or more than the instrument range.*
12. Remove the prepared sample from the cell holder.
13. Immediately empty and rinse the sample cell. Rinse the sample cell and cap three times with deionized water.

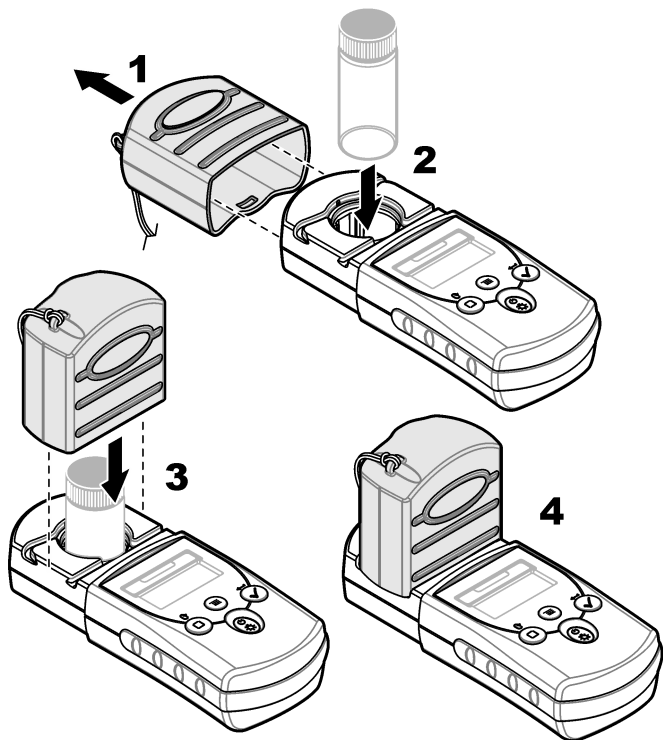


Figure 6 Sample cell orientation



<p>1 Orientation mark</p>	<p>2 Sample cell, 25-mm (10 mL)</p>	<p>3 Sample cell, 1-cm (10 mL)</p>
---------------------------	-------------------------------------	------------------------------------

Figure 7 Install the instrument cap over the cell holder



### 5.3 Show the recorded measurements

Refer to the "rCL" option in [Configure the instrument](#) on page 13.

## 5.4 Standard calibration adjust









Use the standard calibration adjust (SCA) option when a calibration must be adjusted to meet regulatory requirements. The factory calibration is adjusted slightly with the standard calibration adjust (SCA) option so that the instrument shows the expected value of the standard solution. The adjusted calibration is then used for all test results. This adjustment can increase the test accuracy when there are slight variations in the reagents or instruments.

**Note:** For instruments with factory-calibrated ranges or methods, the standard calibration adjust (SCA) feature is disabled when a user-entered method is entered into the instrument. To set SCA back to on, set the instrument to the factory default calibration. Refer to [Set to the factory default calibration](#) on page 22.

### 5.4.1 Adjust the factory calibration with a standard

1. Complete the test procedure for the range to calibrate. For the sample, use the standard solution concentration given in the test procedure documentation.






**Note:** If a standard solution concentration is not given in the test procedure documentation, a different known standard can be used.

2. When the test procedure is completed, push .
3. Push  until "SCA" shows, then push .  
The display shows the standard calibration adjust value.
4. If a different known standard is used, enter the value of the standard:
  - a. Push  until "Edit" shows, then push .
  - b. Push  to enter the value of the standard. Push  to go to the next digit.
5. Push  to add the standard calibration adjust value to the factory calibration curve.

The calibration adjusted icon shows on the display. Refer to [Figure 5](#) on page 12.

### 5.4.2 Set the standard calibration adjust to off

To use the factory default calibration again, set standard calibration adjust (SCA) to off.

1. Push .
2. Push  until "SCA" shows, then push .
3. Push  until "OFF" shows, then push .

**Note:** To set the SCA function to on again, calibrate with a standard.

## 5.5 User-entered calibration

This instrument accepts a user-prepared calibration curve. The calibration curve can be from 0 to 2.5 absorbance. Make sure that the calibration curve includes standard values that are less and more than the range of interest.

The instrument range will be the same as the calibration range. For example, when the standards that are used are 1.00, 2.00 and 4.00. The instrument range is 1.00 to 4.00.

There are two options to enter a user calibration curve:

- **Enter a calibration curve with standards**—The standard solution values are entered with the keypad and the absorbance values are measured.
- **Enter a calibration curve with the keypad**—The standard solution values and absorbance values are entered with the keypad.

**Note:** If the instrument is set to off or the instrument power is removed before a user-entered calibration curve is completed, the calibration curve is not saved. The instrument automatically switches off in user-entered calibration entry mode after 60 minutes of no activity. User-entered calibrations are completed when the user goes out of calibration (cal) mode or edit mode.

### 5.5.1 Channel restrictions

A user-entered calibration curve can be entered into any channel that does not contain a factory-programmed curve. These channels have the label:


- "abs" on the instruments that have a single factory calibration



- “1” and “2” on the single wavelength instruments that are not calibrated

Any chemistry that can be done at the instrument wavelength can contain a user-entered calibration in these channels.






### 5.5.2 Enter a calibration curve with standards

**Note:** Deionized water can be used for the blank unless the sample is significantly more turbid or has more color than deionized water.

1. Set the instrument to the range to calibrate. Refer to [Configure the instrument](#) on page 13.
2. Prepare the blank and the reacted standard solution. Refer to the test procedure. Let the color fully develop.
3. Set the instrument to zero.
  - a. Insert the blank sample cell in the cell holder.
  - b. Install the instrument cap over the cell holder.
  - c. Push . The display shows “- - -”, then “0.000”.
  - d. Remove the instrument cap.
  - e. Remove the sample cell from the cell holder.

4. Push and hold  until “USER” and then “CAL” shows, then push .






**Note:** If “USER” and “CAL” do not show, the factory calibration cannot be changed on the selected range.

5. If “RES” shows on the display, set the resolution.
  - a. Push . The resolution setting (decimal placement) shows.
  - b. To change the resolution, push , then . Push  to save the change.
  - c. To not change the resolution, push .

**Note:** “RES” does not show on the display of factory-calibrated instruments because the resolution cannot be changed. Only instruments that are not factory calibrated or have “abs” as one of the two ranges show “RES” on the display.

## Operation

---



6. When "S0" shows on the display, push ✓. Push  to enter the blank value, then push ✓.  
*Note: Push ✓ to go to the next digit.*
7. When "A0" shows on the display, measure the absorbance of the blank.
  - a. Insert the blank sample cell in the cell holder.
  - b. Install the instrument cap over the cell holder.
  - c. Push ✓. The display shows the absorbance value for "S0".
  - d. Remove the sample cell from the cell holder.
8. Push  to show "S1".
9. When "S1" shows on the display, push ✓. Push  to enter the first standard value, then push ✓.  
*Note: Push ✓ to enter the next digit.*
10. When "A1" shows on the display, measure the absorbance of the reacted standard solution.
  - a. Insert the reacted standard sample cell in the cell holder.
  - b. Install the instrument cap over the cell holder.
  - c. Push ✓. The display shows the absorbance value for "S1".
  - d. Remove the sample cell from the cell holder.
11. The calibration is completed with two calibration points. If additional standards are necessary for calibration:
  - a. Push  until "Add" shows, then push ✓.
  - b. Do steps 9–10 again to enter more standards.
12. Push  two times to go back to measurement mode.

### 5.5.3 Enter a calibration curve with the keypad



At least two data pairs are necessary to enter a user-prepared calibration curve. A concentration value and the absorbance value for the given concentration is necessary for each data pair. A maximum of 10 data pairs can be entered.

*Note: This procedure can also be used to change the data pairs in a user-entered calibration curve or factory calibration curve.*

1. Set the instrument to the range to calibrate. Refer to [Configure the instrument](#) on page 13.




2. Push and hold  until "USER" and then "CAL" shows, then push .

**Note:** If "USER" and "CAL" do not show, the factory calibration cannot be changed on the selected range.

3. Push  until "EDIT" shows, then push .

4. If "RES" shows on the display, set the resolution.


a. Push . The resolution setting (decimal placement) shows.




b. To change the resolution, push , then . Push  to save the change.

c. To not change the resolution, push .

**Note:** "RES" does not show on the display of factory-calibrated instruments because the resolution cannot be changed. Only instruments that are not factory calibrated or have "abs" as one of the two ranges show "RES" on the display.


5. When "S0" shows on the display, push . Push  to enter the concentration value of the first data pair, then push .

**Note:** Push  to go to the next digit.


6. When "A0" shows on the display, push . Push  to enter the absorbance value of the first data pair, then push . "S1" shows on the display.

7. Do steps 5–6 again to enter the second data pair (S1 and A1).

8. The calibration is completed with two data pairs. If additional data pairs are necessary for calibration:









a. When "Add" shows, push .

b. Do steps 5–6 again to enter more data pairs.




9. Push  two times to go back to measurement mode.

### 5.5.4 Remove a calibration point

To remove a calibration point from a user-entered calibration curve:

1. Set the instrument to the range to calibrate. Refer to [Configure the instrument](#) on page 13.
2. Push and hold  until "USER" and then "CAL" shows.  
**Note:** If "USER" and "CAL" do not show, the factory calibration cannot be changed on the selected range.
3. Push  until "EDIT" shows, then push .
- Note:** Calibration points can also be removed in calibration (CAL) mode.
4. Push  until the calibration point to remove shows (i.e., S0 or S1), then push .
5. Push  until "dEL" shows, then push .
- Note:** The minimum number of data pairs is two. When only two data pairs remain, no more data pairs can be removed.
6. Push  two times to go back to measurement mode.

### 5.5.5 Set to the factory default calibration

1. Set the instrument to the applicable range. Refer to [Configure the instrument](#) on page 13.
2. Push and hold  until "USER" and then "CAL" shows.  
**Note:** If "USER" and "CAL" do not show, the factory calibration cannot be changed on the selected range.
3. Push  until "dFL" shows, then push .



## Section 6 Maintenance

### ⚠ CAUTION



Multiple hazards. Only qualified personnel must conduct the tasks described in this section of the document.

### NOTICE

Do not disassemble the instrument for maintenance. If the internal components must be cleaned or repaired, contact the manufacturer.

## 6.1 Clean the instrument

Clean the exterior of the instrument with a moist cloth and a mild soap solution and then wipe the instrument dry.

## 6.2 Clean the sample cells

### ⚠ CAUTION



Chemical exposure hazard. Obey laboratory safety procedures and wear all of the personal protective equipment appropriate to the chemicals that are handled. Refer to the current safety data sheets (MSDS/SDS) for safety protocols.

### ⚠ CAUTION



Chemical exposure hazard. Dispose of chemicals and wastes in accordance with local, regional and national regulations.

Most laboratory detergents are used at recommended concentrations. Neutral detergents, such as Liquinox, are safer to use when regular cleaning is necessary. To decrease the cleaning times, increase the temperature or use an ultrasonic bath. To complete the cleaning, rinse a few times with deionized water and then let the sample cell air dry. Sample cells may also be cleaned with acid, followed by a thorough rinse with deionized water.


**Note:** Always use acid to clean sample cells that were used for low-level metal tests.

Special cleaning methods are necessary for individual procedures. When a brush is used to clean sample cells, take extra care to avoid scratches on the interior surfaces of the sample cells.

### 6.3 Replace the batteries

Replace the batteries when the battery power level is low. Refer to [Install the batteries](#) on page 9.

## Section 7 Troubleshooting

Error	Description	Solution
E-0	No zero	In user calibration mode, a standard solution was measured before the instrument zero was set. Measure a blank solution to set the instrument to zero.
E-1	Ambient light error <sup>1</sup>	There is ambient light in the cell holder. Make sure that the instrument cap is fully installed over the cell holder.
E-2	LED error <sup>1</sup>	The LED (light source) is out of regulation. Replace the batteries. Make sure that the LED in the cell holder comes on when ✓ or  is pushed.
E-3	Standard adjust error	<ul style="list-style-type: none"><li>• The measured value of the standard solution is more than the adjustment limits. Prepare a fresh standard.</li><li>• The standard solution is not within the concentration range that can be used for standard calibration adjust. Prepare a standard with a value at or near the recommended concentrations given in the procedure.</li><li>• Make sure that the concentration of the standard solution is entered correctly.</li></ul>
E-6	Abs error	The absorbance value is not correct or the user-entered calibration curve has fewer than two points. Enter or measure the absorbance value again.
E-7	Standard value error	The standard solution concentration is equal to another standard solution concentration that is already entered in the user-entered calibration curve. Enter the correct standard concentration.
E-9	Flash error	The instrument is not able to save data.

## Troubleshooting

---

Error	Description	Solution
Reading flashes	The reading is more or less than the instrument range. <sup>2</sup>	If the reading is less than the instrument range, make sure that the instrument cap is fully installed over the cell holder. Measure a blank. If the blank reading is not zero, set the instrument to zero again.
		If the reading is more than the instrument range, identify if there is a light blockage in the cell holder. Dilute the sample. Do the test again.
		For factory-calibrated programs, the maximum and minimum values always equal the factory-calibrated values and cannot be changed.

- <sup>1</sup> When an E-1 or E-2 error occurs on a measurement, the display shows “\_.\_”. The decimal place depends on the chemistry. If the E-1 or E-2 error occurs while the instrument is set to zero, set the instrument to zero again.
- <sup>2</sup> The flashing value will be 10% over the upper test range limit.

## Section 8 Replacement parts

### ⚠ WARNING



Personal injury hazard. Use of non-approved parts may cause personal injury, damage to the instrument or equipment malfunction. The replacement parts in this section are approved by the manufacturer.

**Note:** *Product and Article numbers may vary for some selling regions. Contact the appropriate distributor or refer to the company website for contact information.*

### Replacement parts

Description	Quantity	Item no.
AAA batteries, alkaline	4/pkg	4674300
Cap cord	1	5955900
Instrument cap	1	5954800
Sample cell, 25 mm (10 mL), with caps	6/pkg	2427606
Sample cell, 1 cm (10 mL), with caps	2/pkg	4864302





**HACH COMPANY World Headquarters**

P.O. Box 389, Loveland, CO 80539-0389

U.S.A.

Tel. (970) 669-3050

(800) 227-4224 (U.S.A. only)

Fax (970) 669-2932

orders@hach.com

www.hach.com

**HACH LANGE GMBH**

Willstätterstraße 11

D-40549 Düsseldorf, Germany

Tel. +49 (0) 2 11 52 88-320

Fax +49 (0) 2 11 52 88-210

info@hach-lange.de

www.hach-lange.de

**HACH LANGE Sàrl**

6, route de Compois

1222 Vézenaz

SWITZERLAND

Tel. +41 22 594 6400

Fax +41 22 594 6499